

Assembly Technology – Modular, Flexible, Ergonomic

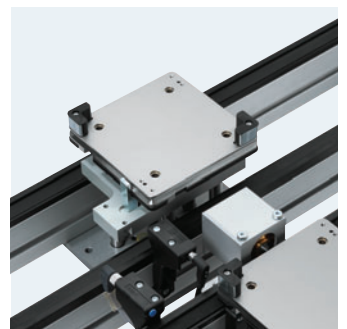

Rexroth assembly technology – the best foundation for efficient production





Assembly technology at a glance

- 04 Bosch Rexroth –
The Drive & Control Company
- 06 Perfect for your requirements
- 08 Assembly technology –
at home in many industries

Product lines

- 10 Basic Mechanic Elements**
- 12 Profiles, connectors
- 14 *designLINE* version, accessories
- 16 Quick & Easy profile finishes,
EcoSafe protective fence
- 18 Manual Production Systems**
- 20 Workstations, swivel work chairs
- 22 Workstation lighting, drawer cabinet range
- 24 On-hand information, tool positioning
- 26 Case lifters, flow rack systems
- 28 FiFo station, material shuttles,
EcoFlow linking elements
- 30 EcoShape tubular framing system,
grab containers
- 32 Material and information flow technology**
- 34 TS 1 transfer system
- 36 TS 2*plus* transfer system
- 38 TS 5 transfer system
- 40 TS 2*pv* transfer system
- 42 VarioFlow *plus* chain conveyor system
- 44 ID200, ID40, ID15 identification systems
- 46 Planning tools MT*pro***

Supplementary information

- 48 Customer-specific solutions and projects
- 51 Service



Move to a top position with us

When it comes to driving, controlling, and moving, companies rely on Rexroth's expertise. With our complete range of cross-technology solutions and in-depth industry know-how, we rank among the leaders on the market. We form close partnerships with our customers based on mutual trust and transparency in all processes.

Rexroth is The Drive & Control Company.



Everything we do is aimed to meet the particular requirements of our customers. In cooperation with our partners, we support you in designing and planning ergonomic and efficient assembly systems to ensure lean production. Whatever the application area, we always work together with you to find the most practical and future-proof solution – from tried and tested standard designs to a customized high-end system that can still be modernized or adapted to new challenges even after many years.

Our approach is integrated and comprehensive. Our actions are solution, performance, and results-oriented. Flexibility, energy efficiency, and sustainability are crucial factors in our forward-looking strategy.

Tough application, ingenious solution.

Transportation solutions for all requirements

With our versatile assembly technology, we develop sustainable solutions for your special requirements. We draw on our many years of applied experience in industrial production in a wide spectrum of sectors. You benefit from the advantages of our unique, comprehensive product range of components for all types of driving, controlling, and moving.

What makes our approach unique? All relevant technologies are combined in integrated cross-system applications – from electric drives and controls to hydraulics and linear and assembly technologies.

With Rexroth, you win all along the line. Benefit from system solutions and cross-system, integrated applications that only Rexroth can deliver in all their complexity on a global scale – including in assembly technology.

Perfect for your requirements – anything is possible



Sustainable equipment for a fast-paced market

Product life cycles continue to shrink in many industries and innovations are ready for series production faster than ever. Assembly technology must keep up with the increasing pace in development and production, which calls for flexible solutions that are easy to convert or extend without any major effort.

Versatile planning concepts

With Rexroth assembly technology, you are already preparing for tomorrow's challenges. You benefit from our complete system range that has been continually developed, supplemented, and optimized for many years to be able to cover a wide spectrum of requirements.

- ▶ System solutions that are quick and easy to scale for any application
- ▶ Efficient, quick planning and configuration with the user-friendly MTpro software
- ▶ Modular system for fast implementation
- ▶ Standard systems and custom solutions

From manual to fully-automated

Many years of experience in assembly technology and extensive knowledge of the industry allow us to realize efficient, productive systems for you in no time at all. From ergonomic manual stations to fully automatic production systems, we provide you with the perfect solution to reach your goals quickly, reliably, and safely.

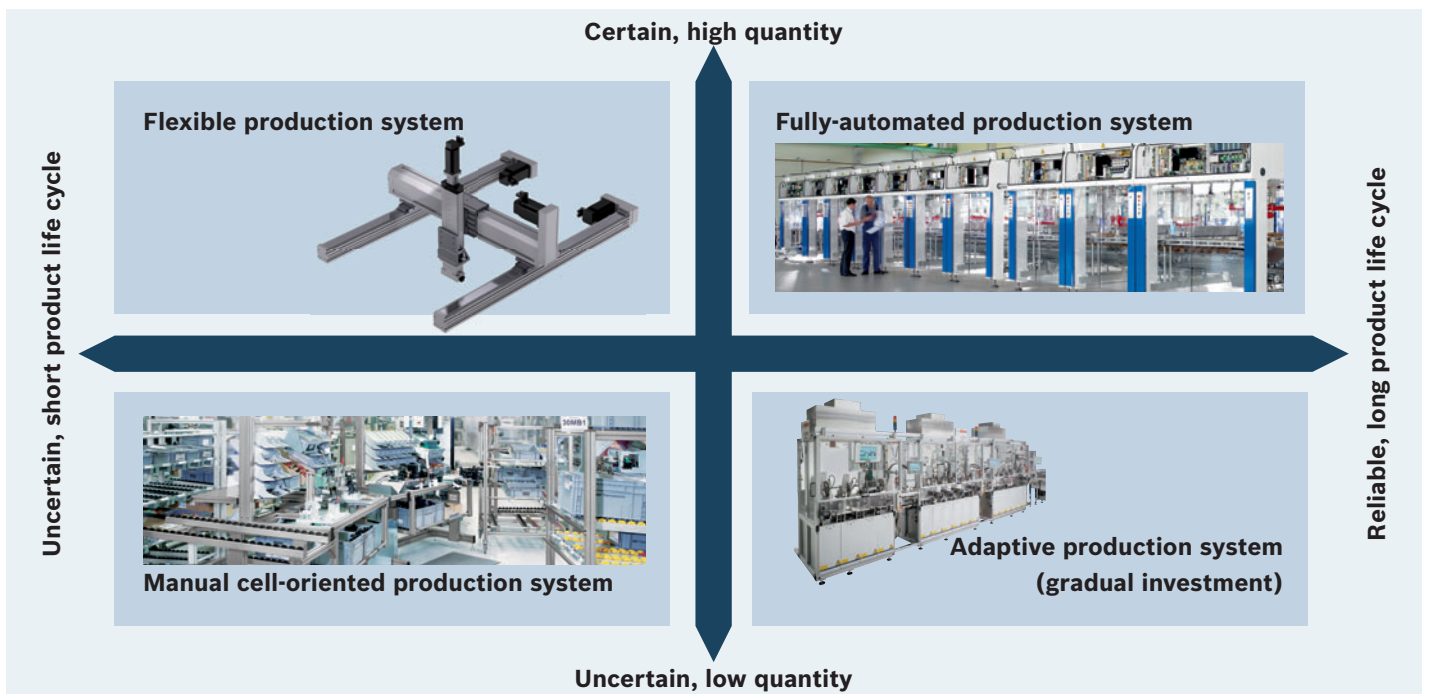

Depending on the annual production quantity, a different degree of automation may be recommended. We support you in finding the best system for your requirements. This allows you to realize basic constructions, such as enclosures or workstations, as well as customized transfer, chain conveyor, and identification systems.

Higher productivity, less effort

Finely tuned individual components and integrated systems interact perfectly and simplify the development and design process.

Lean production for higher efficiency

Lean, waste-free production begins with the efficient, low-waste planning of production lines tailored according to customer requirements. Activities that do not add value are minimized continuously.

Ergonomics increase performance

Ergonomically designed workstations and user-friendly production systems ensure that your employees can efficiently manage and focus on workflows.

Ideal for ESD, cleanroom, or dry room applications

We meet the requirements of special production conditions, for example for ESD, cleanroom, and dry room applications. Contact us directly for product details.

Customer orientation and industry expertise – our experience gives you a leg-up

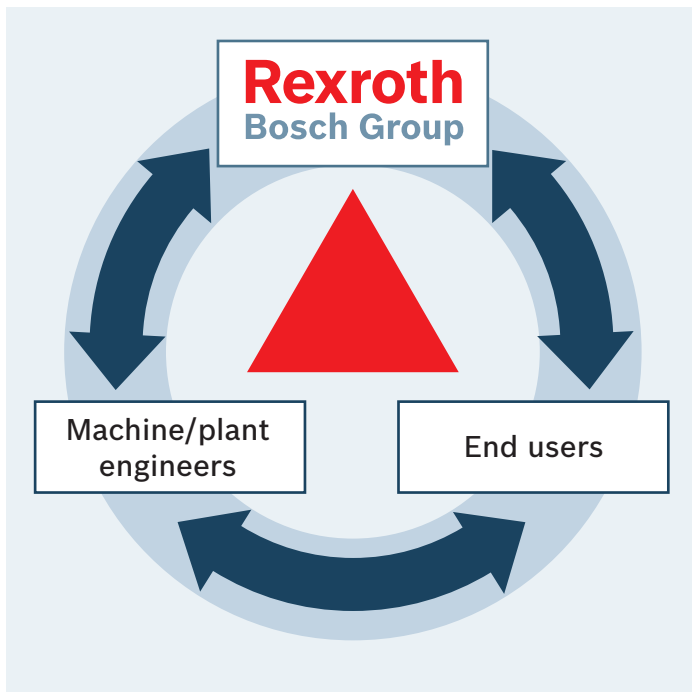

Our relationship with our customers couldn't be any more dynamic: Bosch Rexroth is closely involved with machine manufacturers and plant engineers who develop and realize high-performance solutions for their customers using our components. At the same time, we support end users directly in expanding their systems with individual components or complete modules. End user benefit from both the expertise of the plant engineer and the immediate support of Rexroth's assembly technology specialists.

Fast planning and implementation phases

Whether production conditions have to be adapted to new requirements quickly, changes to products are underway, or different batch sizes are needed – with Rexroth Assembly Technology and the MTpro planning software, you can optimize your system for new processes in no time at all. Today's strong market dynamics require the immediate implementation of the necessary production systems directly after investment. Rexroth supports you with fast

delivery times and quick, simple commissioning. The finely tuned system components are assembled and ready for operation in an instant.

Productivity

Minimal assembly effort, perfect interaction of all components, and the ease of use of Rexroth systems lay an excellent foundation for efficient, time-saving, and resource-saving production.

Always ready for the future

Shorter product life cycles require adaptable assembly technology. Rexroth's modular system allows for quick, efficient retrofitting for manufacturing successor product generations.



▲ Automotive
▼ Medical industry/pharmaceuticals



▲ Battery production
▼ Assembly and handling



▲ Electrical and electronics industry
▼ Food industry



▲ Consumer goods production
▼ Solar production



Monitor the flow of production

For detailed traceability of products and production data, we provide the required systems (e.g. RFID), enabling maximum transparency for optimized quality management.

Energy Efficiency

With our wide spectrum of innovative drive and control concepts, we cover virtually all requirements in many different industries. All systems interact perfectly and are designed for maximum productivity with minimum energy consumption in accordance with Rexroth's 4 EE principle.

Assembly technology – at home in many industries.

Complete product and system range available worldwide via country units and sales partners for

- ▶ Automotive
- ▶ Battery production
- ▶ Electrical and electronics industry
- ▶ Consumer goods production
- ▶ Mechanical engineering
- ▶ Medical technology and pharmaceuticals
- ▶ Assembly and handling
- ▶ Food industry
- ▶ Solar production
- ▶ Packaging industry
- ▶ and many more.

Basic Mechanic Elements – multi-talented product range



The original modular assembly system – uncompromisingly flexible. Working environments are more efficient the more precisely they are tailored to the individual application. With Rexroth’s flexible assembly system, you can quickly find comprehensive solutions for all the tasks in your industry.

Introduced over 30 years ago, the Rexroth modular system for assembly technology has been expanded and optimized continuously. It currently consists of over 1,500 components for all areas of production: from simple frames, to enclosures, standard and special machines, ESD-capable systems, all the way to manual workstations or lines for material supply and linking.

The system concept is irresistibly simple: it is based on modest, but highly robust aluminum profiles with “limitless” longitudinal slots. Together with the free-of-charge MTpro planning software and our comprehensive support, our modular assembly technology system offers everything you need for configuring efficient work environments.

Basic Mechanic Elements**Your advantages:**

- ▶ The largest modular profile system worldwide
- ▶ Minimal planning effort
- ▶ Fast assembly time
- ▶ Few tools
- ▶ Flexible removal and conversion
- ▶ Reusable
- ▶ Finished surfaces

Accessories**Your advantages:**

- ▶ Wide variety of parts
- ▶ Adapted to strut profiles
- ▶ ESD-compliant components
- ▶ Complete linear guides
- ▶ LF-MGE Linear Motion Designer

Quick & Easy profile finishes**Your advantages:**

- ▶ Many machining options at nearly every point on the profile
- ▶ Easy configuration via eShop and MT*pro* or fax and manually
- ▶ Simple logistics and fast delivery times

Basic Mechanic Elements

With its wide selection of profile cross sections, Rexroth's modular aluminum framing system is the most comprehensive and versatile of its type worldwide. Using these basic elements, you can realize frames, enclosures, protective fences and workstations with minimal planning effort. All components are heavy-duty and corrosion-resistant.

The modular aluminum framing system is even more flexible when combined with the EcoShape tubular framing system, for example for workstation, flow rack, or material shuttle construction.

Accessories

Thanks to a wide variety of different connection elements, you face practically no boundaries in realizing your individual system and making your flow racks, enclosures, or workstations ESD-compliant. The profiles are also available cut to length and machined, saving you time in implementation.

Quick & Easy profile finishes

Thanks to over 500,000 options, bores, milling, threads, and miter cuts are easy to define in detail. With our Quick & Easy configuration in the eShop or MT*pro* planning software, you can plan a customized profile finish. In addition to the order code, you receive a CAD model or dimensioned drawing, as required. You can submit your order and receive your delivery in no time at all.

Aluminum strut profiles

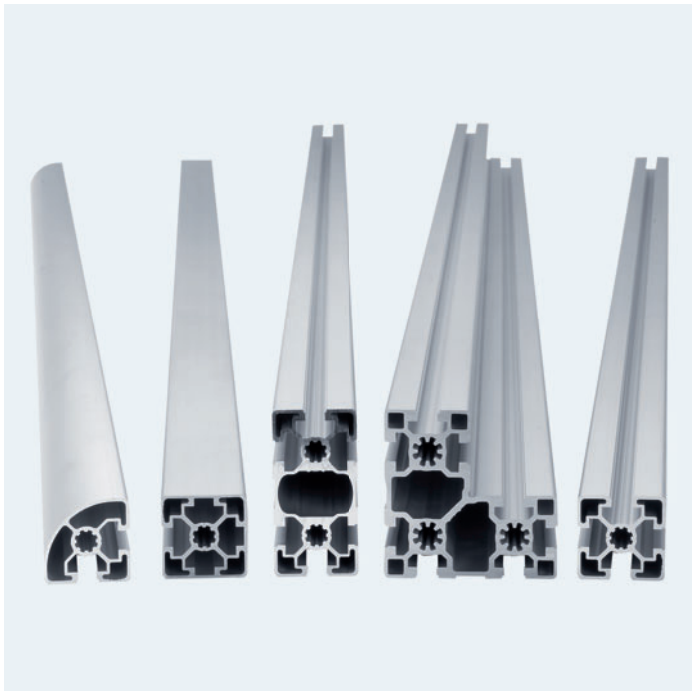

Flexibility with no compromises

With well over 100 profile cross sections, we offer you the largest modular strut profile system worldwide for a wide variety of applications. With precisely matched modular dimensions, versatile connection elements, and accessories, you can make virtually any idea a reality. One more plus: our profiles are all compatible.

Advantages

- ▶ Most comprehensive modular product range among the competition
- ▶ Highly durable standard profiles
- ▶ Innovative special profiles
- ▶ Profiles with closed slots
- ▶ Guaranteed performance data, highest stability criteria
- ▶ Customer-specific profile finishing (Quick & Easy)
- ▶ Available worldwide

Key technical data

- ▶ Approx. 140 profile cross sections
- ▶ Finely graduated profile size range (20, 30, 40, 45, 50, 60, 80, 90, 100 mm)
- ▶ 3 slot systems: 6, 8, 10 mm with slot-independent connectors
- ▶ Slot retention forces up to 24,000 N

Customer applications

- ▶ For all industries, especially assembly and handling
- ▶ Frame assembly, apparatus engineering, special systems, machine construction

Connection technology



Reliable, sturdy, and stable

The right connection element for every application – not a problem with Bosch Rexroth's modular profile system. Create safe solutions with ingeniously engineered connection technology.

Advantages

- ▶ Highly durable connection technology with/without profile finishing
- ▶ Innovative product features such as position recognition, centering lugs, ultra scratch-proof coatings, etc.
- ▶ Guaranteed performance data
- ▶ Available worldwide

Key technical data

- ▶ 28 types of connectors in 280 variants
- ▶ Profile size ranges: 6, 8, 10 mm with slot-independent connectors
- ▶ Slot retention forces up to 24,000 N
- ▶ Displacement forces up to 15,000 N
- ▶ Completely ESD-conductive

Customer applications

- ▶ Technical and design-oriented solutions
- ▶ For all industries, especially assembly and handling
- ▶ Frame assembly, apparatus engineering, special systems, machine construction

designLINE



An appealing connection of quality and performance

The *designLINE* version of the proven die-cast connectors feature a high-quality appearance that seamlessly integrates into the strut profiles. The special aluminum-colored coating enhances the overall look for your application. No matter whether a trade fair exhibit, an application in production, assembly, or elsewhere.

Advantage

- ▶ Scratch-resistant coating
- ▶ ESD-capable
- ▶ Color-matched to the aluminum profile
- ▶ High-quality appearance

Key technical data

- ▶ Load values equal standard connectors

Customer applications

- ▶ Frame assembly, enclosures, workstations

Accessories



Adapted to the profile system

With versatile accessories, along with matching profile cross sections and diverse connection elements, you can make virtually any idea a reality.

With a wide range of hinges, sliders, clamping elements, feet and rollers, installation and air-supply elements, as well as cover and mounting rim profiles, countless design options are possible.

Advantages

- ▶ Wide variety of products
- ▶ High-quality materials

Key technical data

- ▶ Approximately 1,000 accessory parts
- ▶ Adapted to slot systems 6, 8, 10 mm and universally
- ▶ ESD capability oriented to the application

Customer applications

- ▶ Frame assembly, enclosures, workstations

Quick & Easy profile finishes



Customer-specific profile finishes

Quick & Easy allows for the ordering and supply of tailored profiles and finishes with a wide variety of combination options, expanding our proven modular profile system to include a multitude of options for customized finishes.

Advantages

- ▶ Customer-friendly configurations
- ▶ Order without drawing
- ▶ Attractive finishing prices
- ▶ Fastest delivery time

Key technical data

- ▶ Over 500,000 possible combinations
- ▶ 30 different finishes per profile
- ▶ Can be configured via the online catalog, eShop, MTpro, or manually

Customer applications

- ▶ Standard finish for using interlocking connectors
- ▶ Simplest nomenclature for orders without drawings
- ▶ Miter cuts

EcoSafe protective fence



Maximum safety and quick set-up

With Rexroth's components for protective barriers, you are on the safe side. The EcoSafe protective fence components can be used flexibly and permit compliance with current standards and guidelines. Thanks to its modular design, EcoSafe is easy to expand and can be modified at any time for both additions and conversions.

Advantages

- ▶ Simple planning thanks to standardized kits
- ▶ Quick set-up thanks to pre-assembled protective frames
- ▶ Flexible modular construction
- ▶ Attractive design, color versions also available
- ▶ Compliance with Machinery Directive 2006/42/EC

Key technical data

- ▶ Around 50 standard components as well as customer-specific protective frame versions
- ▶ Matching kits enable the construction of doors
- ▶ Woven wire grilles also available in signal colors

Customer applications

- ▶ Automotive
- ▶ Safety equipment
- ▶ Logistics
- ▶ Automation

Manual Production Systems – laying the foundation for lean production



Efficiency and cost-effectiveness are our top priorities, along with your individual requirements and productivity. We realize these goals with efficient modular assembly solutions that can flexibly be configured to your needs.

Rexroth's Manual Production Systems are designed to realize lean production. With their three pillars – workstations, material supply, and linking, the Manual Production Systems are based on a comprehensive concept that is configured for maximum efficiency and avoidance of waste.

With Manual Production Systems, you can optimally design ergonomic workstations or complete production lines with minimum effort for your respective application, ensuring maximum productivity. Our intuitive MT*pro* planning software supports you from the planning to the implementation stage of your customized system.

Workstations**Your advantages:**

- ▶ Targeted, optimized use of capacities
- ▶ Work with reduced fatigue
- ▶ Increased productivity
- ▶ Motivated employees

Material supply and flow rack systems**Your advantages:**

- ▶ Various conveyor tracks and rollers
- ▶ Customized equipment and dimensions
- ▶ Simple conversion and easy to expand
- ▶ Efficient thanks to First in – First out principle

Manual linking**Your advantages:**

- ▶ Shorter conversion times
- ▶ Short paths for material supply
- ▶ Flexible adaptation to individual requirements

Workstations

With Rexroth, you can flexibly design your own individual workstation solution. You can choose from custom products, which enable you to put together the perfect solution using numerous parameters. Or select from standard products with fixed dimensions.

In addition, our overall product range also offers a comprehensive spectrum of accessories consisting of workstation lighting, power supply, positioning of information and tools, as well as ESD components and swivel work chairs.

Material supply and flow rack systems

Rexroth flow rack systems offer a wide range of options for storing and supplying materials and containers. No matter the sector – commerce, trades, or industry. The flow rack systems can be used as a supermarket shelf at a central

point or to directly supply containers at the workstation. Rexroth flow rack systems are ultra-efficient and highly future-proof.

Manual linking

With an extensive product range for material supply in your production and at workstations, we have everything you need.

Whether material shuttles, FiFo stations, or manual linking systems. Realize short paths in material supply and flexible adaptations to changing requirements.

Workstations

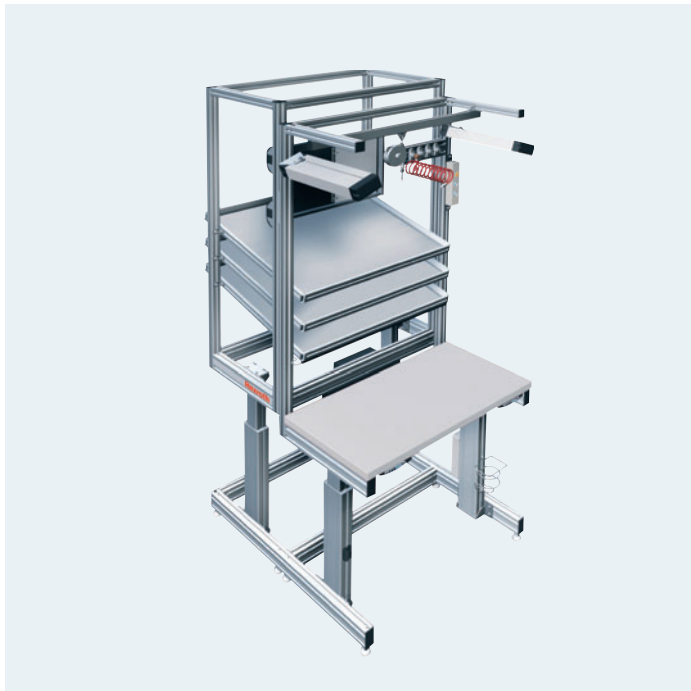

The height of ergonomics and flexibility

You can create ergonomically ideal work conditions with individual, height-adjustable workstations. Customized workstations offer variable dimensions and versatile modules for a flexible design.

Height-adjustable workplaces can be individually adapted to your employees' heights. By easily changing between standing and sitting positions, your employees avoid uneven stresses and premature fatigue.

Advantages

- ▶ Large number of adjustment options for high versatility
- ▶ Freely selectable geometry and functionality
- ▶ Independent adjustment of material supply and table top heights

Key technical data

- ▶ Fully assembled or as a kit for self-assembly
- ▶ Allows for the addition of any desired modules, including cross ties and conveyor tracks as well as individual components
- ▶ Loading capacity up to 400 kg
- ▶ Electrical height adjustment

Customer applications

- ▶ Shift workstations
- ▶ Assembly
- ▶ Packaging
- ▶ Inspection stations

Swivel work chairs



Healthy, functional seating

You can easily optimize the ergonomics of your workstations with functional swivel work chairs that are specifically adapted to the individual application.

These chairs effectively cushion the physical strain caused by repetitive movements. They provide individual support for each employee to ensure a healthy posture throughout their shift.

Advantages

- ▶ Dynamic seating follows employees' movements
- ▶ Ergonomic handles for easy adjustment
- ▶ Optimal lumbar support

Key technical data

- ▶ Tapered backrest
- ▶ Ergonomic seat
- ▶ Synchronous technology with permanent contact
- ▶ Weight adjustment
- ▶ Two height ranges (low 460-610 mm, high 580-820 mm)
- ▶ Version: fabric, PU, ESD, synthetic leather, and cleanroom

Customer applications

- ▶ Electronics
- ▶ Automotive
- ▶ Application in EPA (Electrostatic Protected Area)
- ▶ Optimized ergonomics
- ▶ Dynamic seating

Workstation lighting

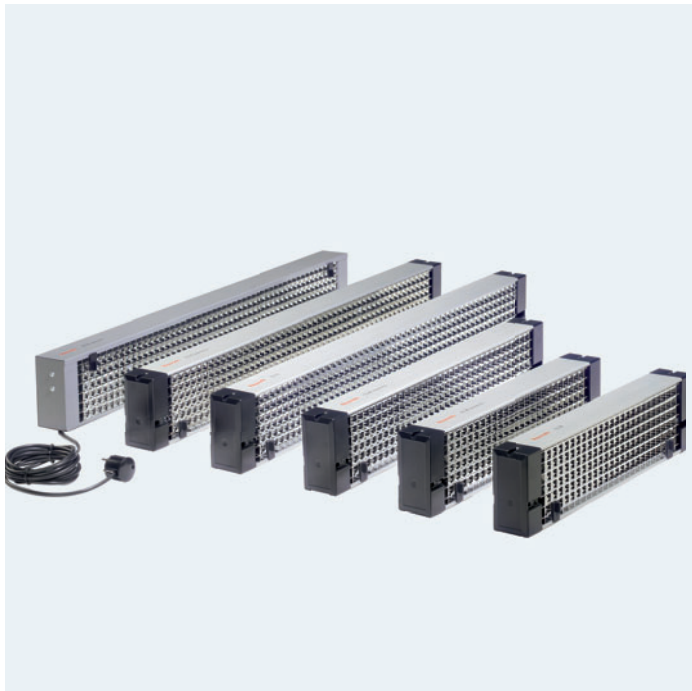

The right lighting for top work quality

Optimum lighting prevents fatigue, improves concentration, and reduces the risk of errors. Rexroth's system lamp range provides glare and flicker-free light of the highest quality. Depending on the task, you can select a single lamp or combine and arrange several lamps at will.

Advantages

- ▶ Up to 25% energy savings thanks to electronic lamp ballasts as per DIN 5008
- ▶ Increased work quality
- ▶ Fast installation and commissioning

Key technical data

- ▶ Flicker-free
- ▶ Color temperature up to 4,000 K
- ▶ Up to 1,500 lux

Customer applications

- ▶ Assembly and manual workstations
- ▶ Inspection stations
- ▶ Packaging stations

Drawer cabinet range



Versatile and functional

With eight pre-configured drawer cabinets, Rexroth's drawer cabinet range offers you functionality of the highest standard.

The functional supply of workstation equipment increases order and tidiness, which in turn increases employee motivation and performance and eliminates time spent searching.

Advantages

- ▶ Functional and individual workstation design
- ▶ Defined surfaces, ergonomic aluminum handle bar with label field
- ▶ Work processes are supported, transparency is increased
- ▶ Easy-to-close, full extension drawers

Key technical data

- ▶ Soft-closing drawer with ball bearing and automatic closing
- ▶ Permissible drawer load: 350 N
- ▶ ESD versions available
- ▶ Drawers can be locked centrally
- ▶ Different drawer partitionings available as an accessory

Customer applications

- ▶ Assembly and manual workstations

On-hand information



Important information on the spot

Using components for information provision, you provide all important information right at the workstation and in production. Your workers can then make the right decisions and take immediate action.

Information provision guarantees a high degree of transparency and is a key prerequisite for certification according to DIN/ISO 9000ff.

Advantages

- ▶ High transparency
- ▶ Increased efficiency thanks to clear organization
- ▶ High stability

Key technical data

- ▶ Can be mounted horizontally or vertically
- ▶ ESD version
- ▶ A4 US format, 2x A4
- ▶ Up to 18 reinforced transparent plastic sleeves

Customer applications

- ▶ Assembly and manual workstations
- ▶ Safety instructions on machines

Optimum positioning of tools



Shorter grab distances make for faster assembly

The ergonomic positioning of tools and parts forms the basis for efficient workstation design. Easy tool accessibility helps to avoid uneven, stressful, and redundant movements.

Advantages

- ▶ Space-saving, ergonomic positioning
- ▶ Reduced assembly time
- ▶ Modular construction
- ▶ Standard part for individual solutions

Key technical data

- ▶ ESD version
- ▶ MTM-optimized
- ▶ Including fastening kit

Customer applications

- ▶ Assembly and manual workstations

Electric case lifter



Lifting and lowering of loads made easier

Case lifters ensure the ergonomic positioning of parts at the workstation. In order to minimize the strain placed on workers' bodies, the case lifter lifts and lowers loads, preventing incorrect posture and overexertion. Your employees can concentrate on value-adding activities.

Advantages

- ▶ Ergonomic parts supply
- ▶ Reduced parts positioning and removal time
- ▶ Automatic stacking/unstacking

Key technical data

- ▶ Lift: 500 mm/900 mm
- ▶ Lifting velocity: 25 mm/s
- ▶ ESD version

Customer applications

- ▶ Assembly and manual workstations

Lean, XLean flow rack systems



Reduce your inventories with an efficient material supply system

A well-structured and clearly organized material supply system generates transparency to help you reduce your stocks. Rexroth's flow rack systems offer users in commerce, trades, and industry a wide range of important benefits.

Advantages

- ▶ Reduced inventories
- ▶ Shorter conversion times
- ▶ Simple conversion, addition, and extension
- ▶ Inventory visualization (kanban color signal)
- ▶ Use of materials in prescribed sequence (FiFo principle)

Key technical data

- ▶ ESD version
- ▶ Fast planning with *MTpro*

Customer applications

- ▶ Assembly and manual workstations
- ▶ Supermarkets
- ▶ Logistics

FiFo stations and material shuttles



Integrated system for kanban supply

Standardized material supply in production using defined delivery routes creates clarity and a high degree of transparency. Observation of the FiFo principle makes it easy to trace material faults or disruptions in the process. The FiFo station can be compared to a supermarket for floor rollers, material shuttles and commissioning shuttles.

Advantages

- ▶ Clear organization and transparency thanks to standardized delivery routes
- ▶ Clear visualization to help minimize inventories
- ▶ Modular rail system design
- ▶ Supports the 5S principle for material supply

Key technical data

- ▶ Plastic guides
- ▶ Construction of flow rack systems, information boards, and height limits through the integration of 30x30 profiles
- ▶ Guide rails bonded/screwed to the floor

Customer applications

- ▶ FiFo station
- ▶ Logistics stations
- ▶ Inventory visualization

EcoFlow



Manual roller sections bring everything closer

The manual linkage of workstations with EcoFlow eases worker strain because products and workpiece pallets are conveyed on manual slide sections. At the same time, investment in such linkage is inexpensive, since the EcoFlow conveyor tracks work without any electric drive systems or controllers.

Advantages

- ▶ Efficient linking of various work steps
- ▶ Ease worker strain (no need to carry heavy loads)
- ▶ Pre-assembled conveyor tracks as an option
- ▶ Can be combined with Rexroth's power-driven transfer systems

Key technical data

- ▶ ESD version
- ▶ Aluminum profile conveyor track
- ▶ Full-width rollers available in plastic, steel, or stainless steel
- ▶ High design flexibility

Customer applications

- ▶ Fifo transport of parts up to 10 kg

EcoShape tubular framing system



Versatile, simple, efficient

With EcoShape, you can build custom structures that require very few components. Planning is easy, too, thanks to the *MTpro* design software, but also due to the structure: standard components are designed in accordance with the poka yoke principle, allowing for quick and error-free assembly.

Advantages

- ▶ High stability with ingeniously engineered connector technology
- ▶ Existing production lines can be expanded easily
- ▶ Easy to cut, assemble, and handle
- ▶ Combination with the modular aluminum framing system for higher loads
- ▶ Configuration and assembly directly on site

Key technical data

- ▶ ESD version
- ▶ Diecast zinc

Customer applications

- ▶ Workstations
- ▶ Material shuttles
- ▶ Flow and transport racks
- ▶ Assembly islands
- ▶ Design solutions

Grab containers, grab ledges

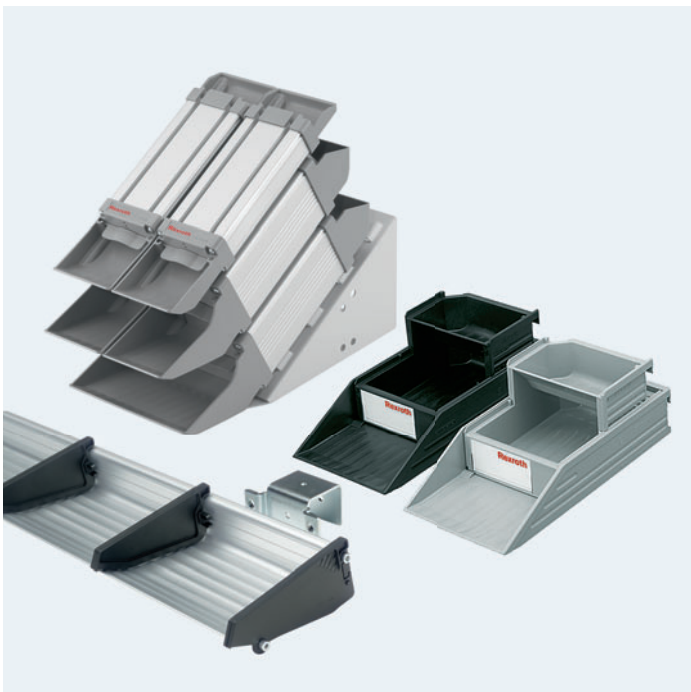

Efficient, reliable gripping of small parts

Rexroth's ergonomically shaped grab containers add to your workstation and assembly stations individually as required and, based on short grab distances, eliminate redundant movements that do not add value. This saves you valuable production time and minimizes strain on your employees.

Advantages

- ▶ Ergonomic, handy supply of small parts such as screws, nuts, and washers
- ▶ Ergonomically designed grab surfaces
- ▶ Fast, secure picking
- ▶ System can be combined (grab containers, grab ledges, covers)

Key technical data

- ▶ Stable, compact stacking
- ▶ Wide range of sizes for flexible design
- ▶ ESD versions available
- ▶ MTM-optimized

Customer applications

- ▶ Assembly and manual workstations

Material and information flow technology – diversity and adaptability

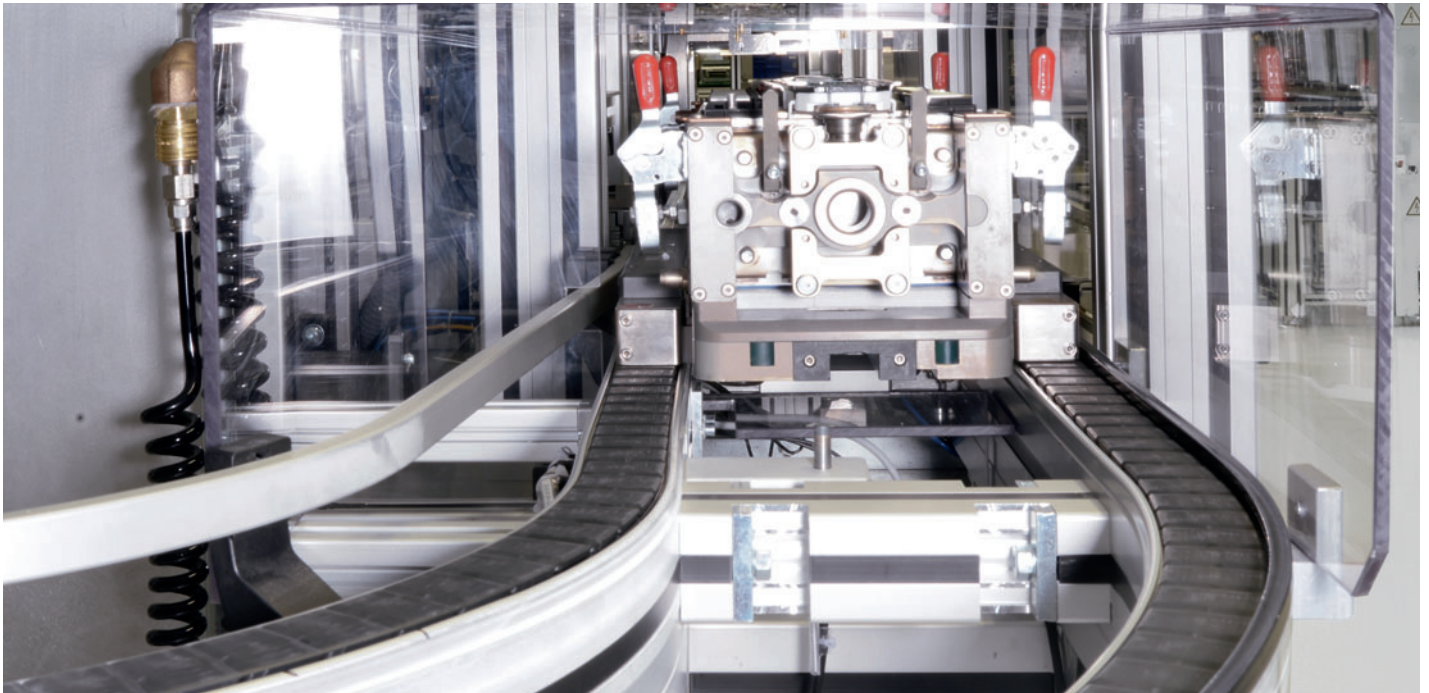

Efficiency for investment and operation, reliability, and adaptability are essential criteria. Experience and expertise from extensive projects with a wide range of requirements make Rexroth your partner of choice.

The requirements are demanding: high quantities with minimum cycle times, fully-automated, or small batches with a wide variety of designs in semi-automated systems with manual workstations. With its proven transfer and chain conveyor systems, Rexroth offers efficient, needs-based, scalable material flow solutions for virtually any application.

Your advantage: All systems have a completely modular design. This facilitates quick planning and configuration – and enables you to expand or convert existing systems with ease. Robust products and innovative technology guarantee high reliability while minimizing maintenance costs.

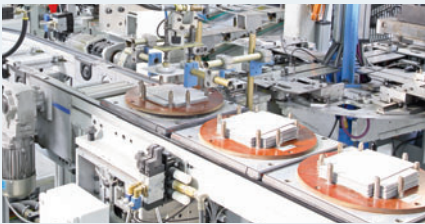
Transfer systems**Your advantages:**

- ▶ For workpieces of just a few grams up to 400 kg
- ▶ High throughput with short cycle times
- ▶ Versatile combination options for the individual modular components

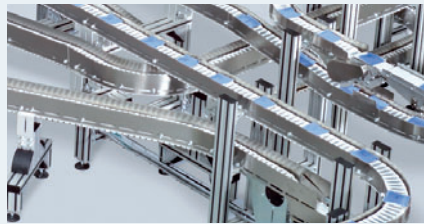
Chain conveyor systems**Your advantages:**

- ▶ Modular design for the simple realization of customized transport sections
- ▶ High tensile forces up to 1,250 N thanks to a minimal number of drives
- ▶ Six standard widths – the right size for every product

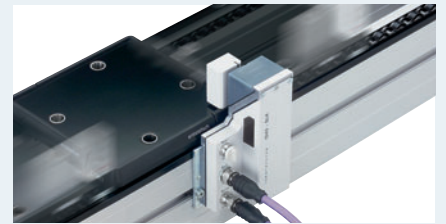
RFID systems**Your advantages:**

- ▶ Quick and reliable identification of workpieces
- ▶ Suitable solutions for all Rexroth transfer systems
- ▶ Flexibility thanks to a wide spectrum of attachment and assembly kits

Transfer systems

No matter whether transporting small, delicate products of only a few grams, or large products weighing several hundred kilograms, in cleanrooms or oily environments, Rexroth's TS 1 to TS 5 transfer systems have stood the test in many industries and are always the right choice.

Chain conveyor systems

Rexroth chain conveyor systems meet hygiene requirements in the food and packaging industry, transport even small parts directly on the nearly closed chain surface, and master ascending and inclined sections with ease – important aspects for linking machines in many industries.

RFID systems

Identification and data storage systems secure the information flow of goods in assembly systems. Data related to objects allow for targeted control of processes and processing steps and is used for type or variant-dependent infeeding and outfeeding of workpiece pallets when manufacturing product variants on multi-branch flexible assembly systems. The documentation of all process steps and production data also assures traceability in the case of a fault.

TS 1 transfer system

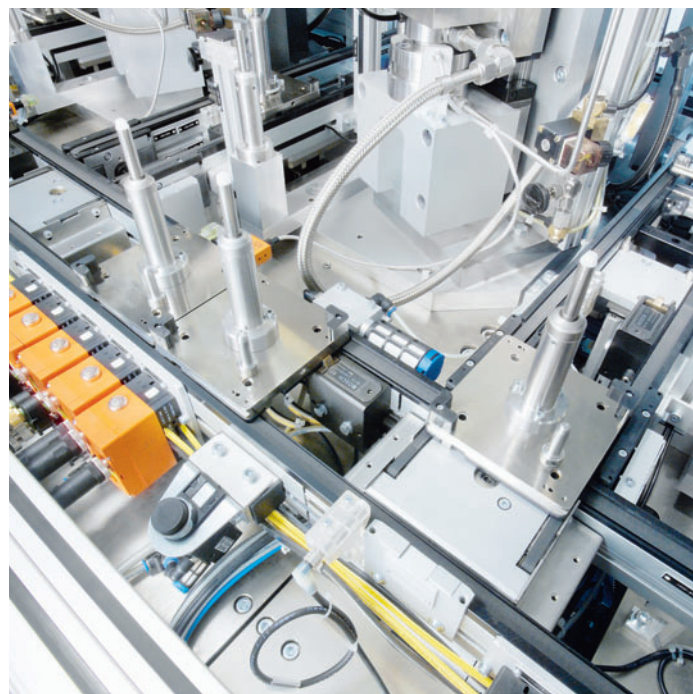

Precise assembly and fast processes

Rexroth's TS 1 transfer system is the right choice when it comes to efficient production of small products or components. It is tailor-made for the precise assembly of complex products. Integration into the preassembly and subassembly processes in a larger system is one of its many strengths.

Advantages

- ▶ Small surface area thanks to its compact construction
- ▶ Suitable for ESD environments, cleanrooms, and dry rooms
- ▶ MTpro planning tool with Layout Designer and automatic generation of parts lists

Special components

- ▶ Accumulation curve for fast throughput times
- ▶ Positioning unit for maximum repeatability and fast workpiece pallet changeover

Key technical data

- ▶ Workpiece pallet weight Up to 3 kg
- ▶ Workpiece pallet sizes 80 x 80 mm
120 x 120 mm
160 x 160 mm
- ▶ Workpiece pallet variants:
plastic, plastic/steel, and aluminum
- ▶ Conveyor media: belt, toothed belt
- ▶ Conveyor speed 6/9/12/15/18 m/min
- ▶ High repeatability Up to +/- 0.015 mm
- ▶ Suitable for class 6 cleanrooms
(EN ISO 14644-1)



Customer applications

Assembly lines in the principal sectors:

- ▶ Automotive
- ▶ Electronics with ESD requirements
- ▶ Medical technology
- ▶ Optical industry

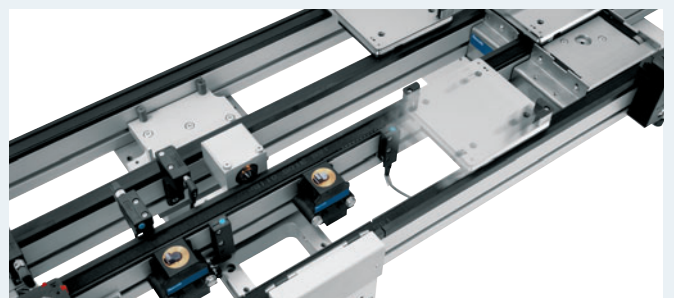

TS 2*plus* transfer system



All-around performance for a wide range of applications

The TS 2*plus* is the versatile choice for efficient assembly systems that has stood the test in thousands of applications worldwide for decades. With workpiece pallets sized 160 x 160 to 1,200 x 1,200 mm and multiple combinable conveyor media, it is an all-around modular system that can be used to implement a wide variety of system layouts.

Advantages

- ▶ High system uptime thanks to mature products
- ▶ Low operating costs thanks to minimal maintenance effort
- ▶ Different conveyor media can be combined optimally in the overall system
- ▶ Suitable for ESD environments, cleanrooms, and dry rooms
- ▶ MT*pro* planning tool with Layout Designer and automatic generation of parts lists

Special components

- ▶ 5 different conveyor media
- ▶ Lift gate for easier access

Key technical data

- ▶ Workpiece pallet weight Up to 240 kg
- ▶ Workpiece pallet sizes 160 x 160 mm up to 1,200 x 1,200 mm
- ▶ Workpiece pallet variants: steel or aluminum carrying plates, or an open frame made of aluminum profiles as an alternative
- ▶ Conveyor media: belt, toothed belt, flat top chain, accumulation roller chain, Vplus chain
- ▶ Conveyor speed 6/9/12/15/18 m/min
- ▶ Section load Up to 200 kg/m in accumulation operation



Customer applications

Assembly lines in the principal sectors:

- ▶ Automotive
- ▶ Electronic devices
- ▶ Electronics with ESD requirements
- ▶ Medical technology
- ▶ Sanitary



TS 5 transfer system



Modular and maintenance-free for loads up to 400 kg

The TS 5 transfer system transports loads of up to 400 kg. With this extremely robust development, Rexroth is introducing a new performance class to the market. This transfer system offers you considerable advantages that will pay off in production, day in and day out.

Advantages

- ▶ Robust, modular, and virtually maintenance-free friction roller conveyor with friction individually adjustable from the outside
- ▶ Suitable for ESD environments, cleanrooms, and dry rooms
- ▶ Modular system for fast delivery times, safe and easy set-up, and quick commissioning
- ▶ MTpro planning tool with Layout Designer and automatic generation of parts lists

Special components

- ▶ Maintenance-free, low-noise, energy-efficient drive concept with king shaft
- ▶ “Open Center” open conveyor section, free access to the workpiece from underneath

Key technical data

- ▶ Workpiece pallet weight Up to 400 kg,
max. 50 kg per roller
- ▶ Workpiece pallet sizes 455 x 455 up to
1,040 x 845 mm
- ▶ Roller dimensions 60 mm
- ▶ Roller spacing 130/195/260 mm
- ▶ Conveyor speed 2 to 18 m/min
- ▶ Suitable for class 6 cleanrooms
(EN ISO 14644-1)

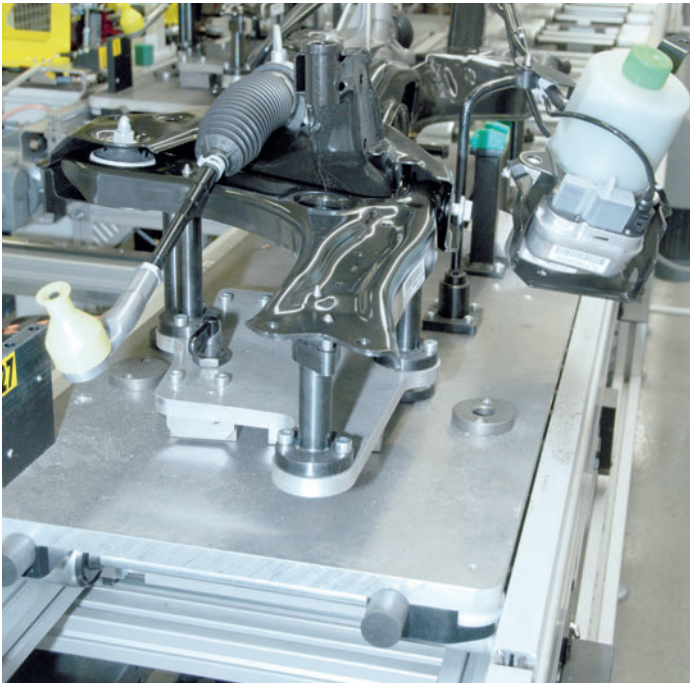

Customer applications

- ▶ Power train assembly lines (axles, transmissions, engines)
- ▶ Battery assembly for electric and hybrid vehicles
- ▶ Assembly of large electrical appliances

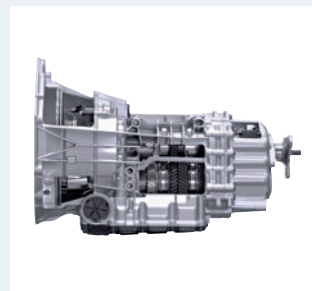

TS 2pv transfer system



Gentle, clean, efficient.

Ideal for module production.

The production of solar modules is an extremely sensitive and complex process that places the highest demands on material transport. The glass plates are large and fragile, but also extremely sensitive to contamination. TS 2pv meets these demanding requirements with exceptional yet cost-effective performance.

Advantages

- ▶ Shock- and vibration-free transport
- ▶ Gentle transfer of the modules from longitudinal to transverse sections
- ▶ Gentle braking and accelerating

Special components

- ▶ Lift transverse unit
- ▶ Application-specific toothed belts for different ambient conditions

Key technical data

- ▶ Panel weight Up to 120 kg
- ▶ Panel sizes Up to 2,200 mm edge length
- ▶ Conveyor sections for transporting hot glass modules of up to 150°C
- ▶ Completely free of silicone, no exposed grease or oils
- ▶ Suitable for class 6 cleanrooms (EN ISO 14644-1)
- ▶ Available in 2, 3, 4, and 5-track versions

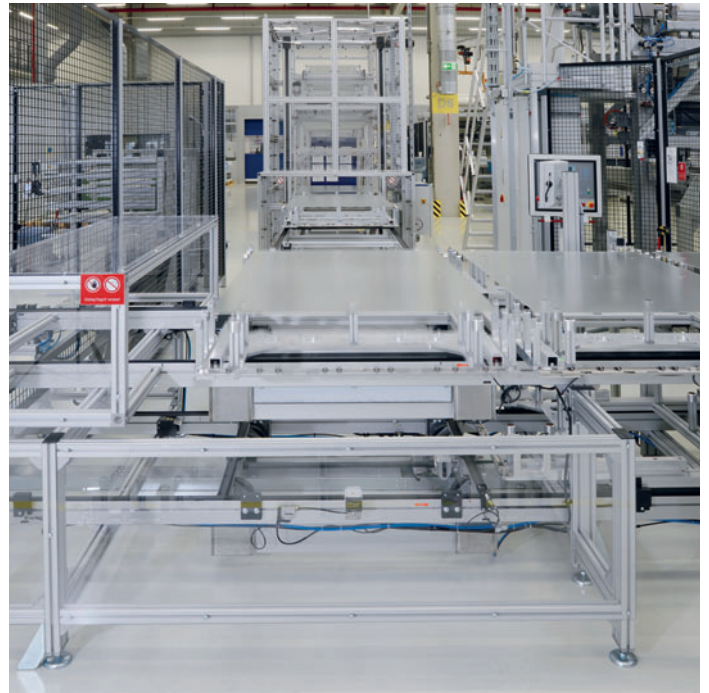

Customer applications

Module production

- ▶ Crystalline solar modules
- ▶ Thin-film solar modules



VarioFlow *plus* chain conveyor system

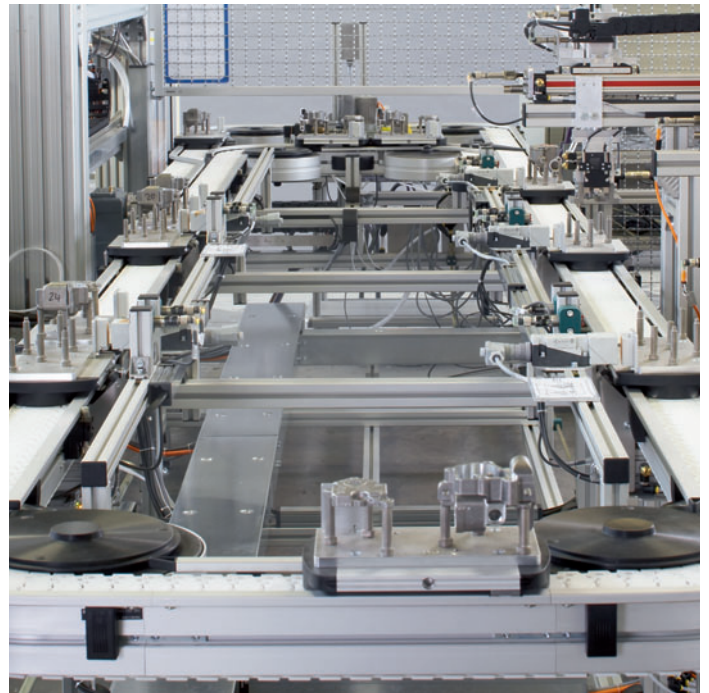
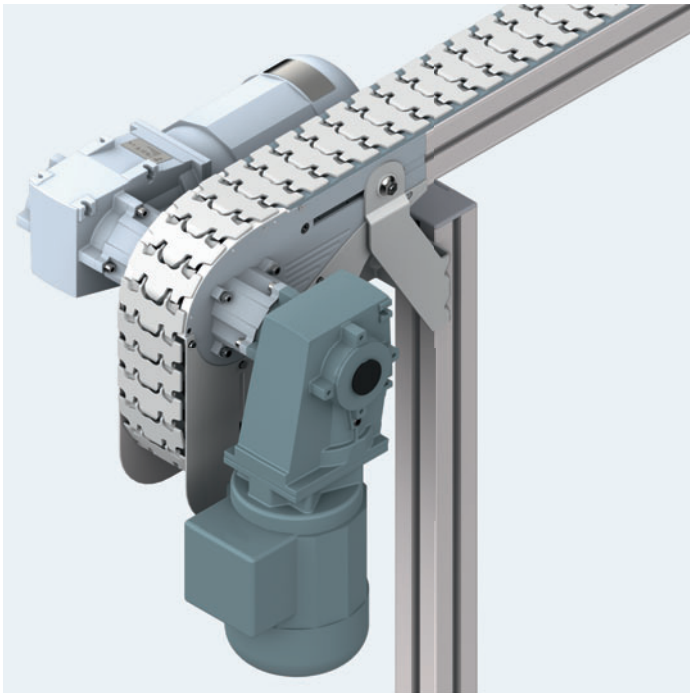

Flexible conveyor system – efficient in action

Today, customer requirements for transport solutions are more demanding than ever. With VarioFlow *plus*, Rexroth offers a conveyor system that is both powerful and versatile. Create your own custom conveyor solution from our comprehensive modular system. Even in tight areas and tricky spaces, VarioFlow *plus* is well equipped to handle any challenge.

Advantages

- ▶ Simple and quick planning with MT*pro*
- ▶ Fast, functional system design without slide rail riveting
- ▶ Optimized sliding characteristics require only few drives and guarantee energy-efficient operation
- ▶ Compliant with current hygiene and safety regulations

Special components

- ▶ Patented chain construction for minimized noise emissions
- ▶ Rivet-free unmachined gliding surfaces
- ▶ Hollow shafts on both sides of the drive and return unit
- ▶ Optional workpiece pallet system

Key technical data

- ▶ Conveyor speed up to 60 m/min
- ▶ Chain width
65/90/120/160/240/320 mm
- ▶ Noise level max. 70 dBA at 40 m/min in operation
- ▶ Aluminum or stainless steel version



Customer applications

Conveyor system for factory automation, enables horizontal and vertical transport of workpieces

- ▶ Food industry
- ▶ Packaging
- ▶ Pharmaceuticals, cosmetics
- ▶ Electronics
- ▶ Automotive
- ▶ Machine linking



RFID systems

Secure, reliable data communication

RFID systems are economic, reliable solutions for implementing a goods-related information flow in assembly systems. Product and order-related data can optionally be stored directly in the data tag (data-on-chip) or in a central database (data-on-network). All Rexroth RFID systems are read/write systems and support all common fieldbuses. They are adapted perfectly to the transfer systems and VarioFlow conveyor system. ID 200 is the ideal system for Ethernet-based communication using standardized data tags in accordance with ISO 15693. Thanks to its high-capacity data tag, ID 40 is particularly suitable for the decentralized storage of large data volumes. With its compact design, ID 15 is perfect for small systems and can be used as a means of decentralized storage.

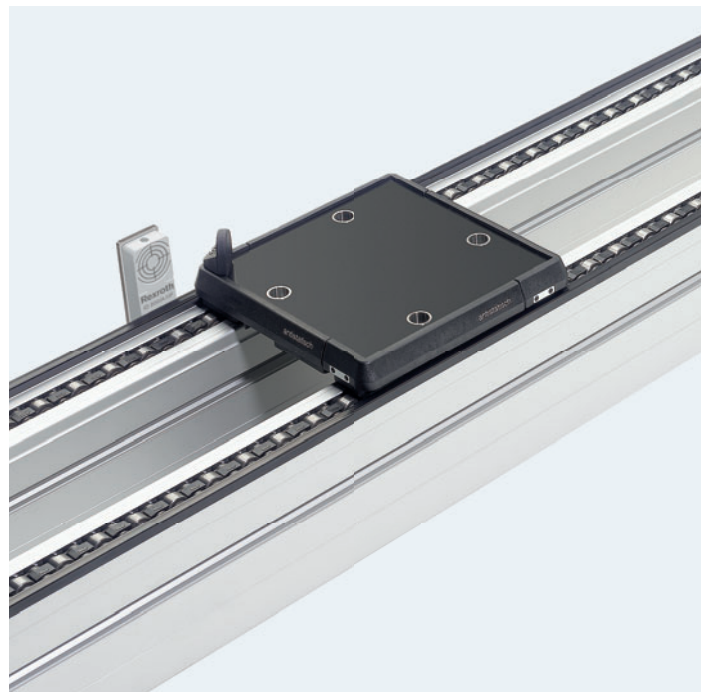

ID 200 technical data

- | | |
|---------------------------------|--------------------------------------------------------------------------|
| ▶ Interfaces | Profibus-DPVO,
RS232, ProfiNet,
Ethernet/IP, TCP/IP,
Modbus/TCP |
| ▶ Transmission frequency | 125 kHz (LF);
13.56 MHz
(HF, ISO 15693) |
| ▶ Transmission distance | Up to 35 mm (HF),
up to 18 mm (LF) |
| ▶ Storage capacity,
data tag | 2 KB FRAM;
5-byte EEPROM |

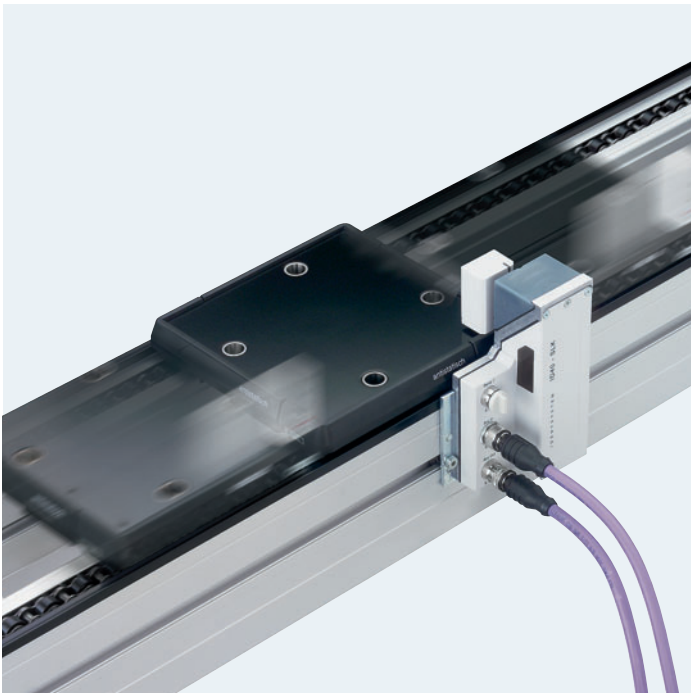
**ID 40 technical data**

- ▶ Interfaces Profibus-DPV0,
RS232
- ▶ Transmission frequency 1280 kHz
- ▶ Transmission distance Up to 12 mm
- ▶ Storage capacity, data tag 2 KB FRAM;
32 KB FRAM

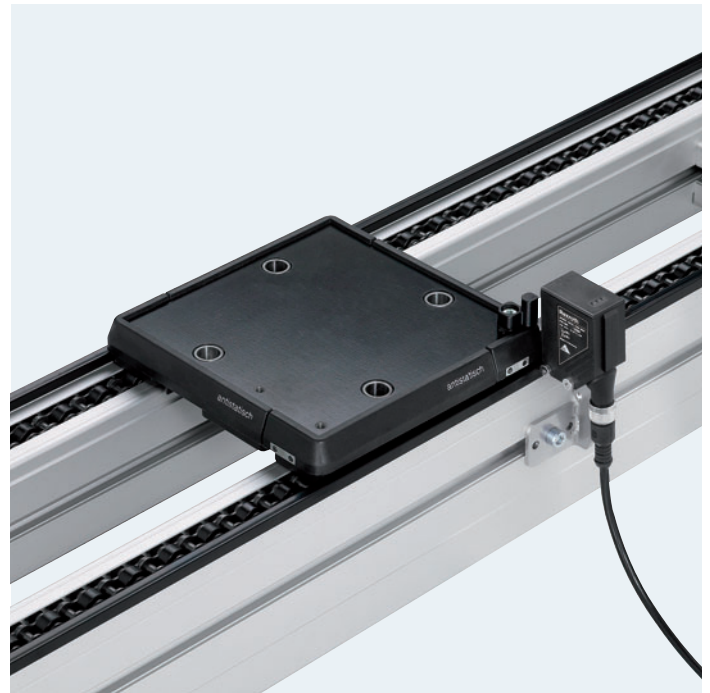
**ID 15 technical data**

- ▶ Interfaces AS-i bus
- ▶ Transmission frequency 125 kHz
- ▶ Transmission distance Up to 20 mm
- ▶ Storage capacity, data tag 15 bit
15-bit EEPROM

MTpro planning software – optimal layouts for assembly systems

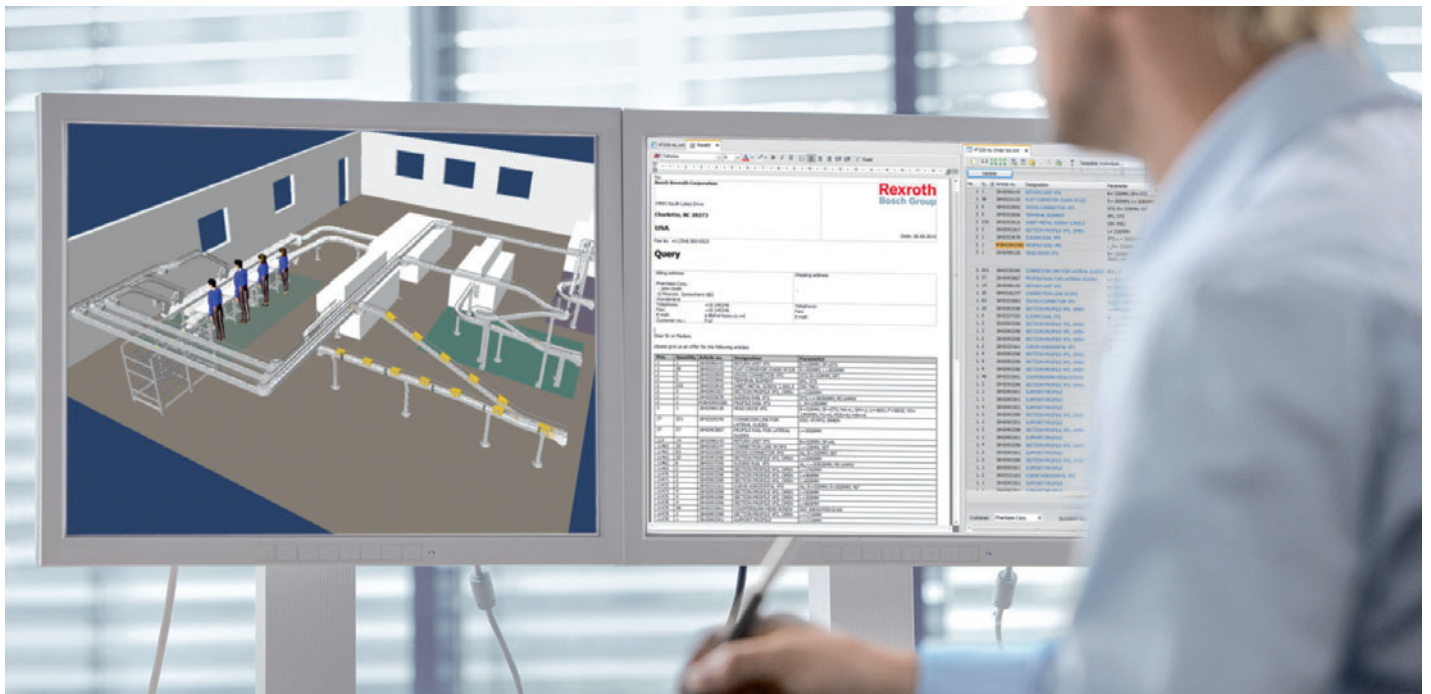

MTpro is an intuitive software program used for planning assembly systems. It assists you along the entire process, from selection to configuration, up to ordering of components.

With MTpro you can plan, calculate, and document your assembly systems in just a few steps. Whether a transfer system, profile frame, or Manual Production System, – with the intuitive operating concept of the Layout Designer, you can create complex designs and system layouts in no time at all.

Components can be selected from the range via drag & drop and assembled quickly and easily using the snap function. You can then simply order the components required for your configuration online. Thanks to an automatic parts list calculation, you always keep your costs under control. Thanks to numerous interfaces, you can also use the planning data for design, purchasing, and service.

MTpro at a glance

Constructions of frames and enclosures with Basic Mechanic Elements

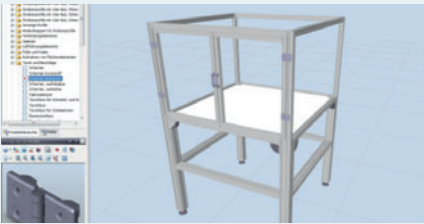

Your advantages:

- ▶ Fast planning of complete frames without CAD software
- ▶ Simple construction with drag & drop
- ▶ User library to reuse your own modules and layouts

Ergonomic design of Manual Production Systems with the ManModel function

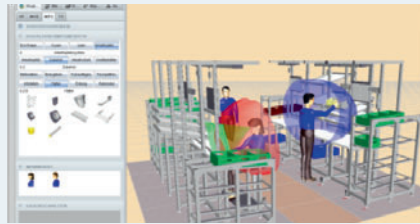

Your advantages:

- ▶ Simulation of reach zones and visual fields with standardized "ManModels" for optimized workstation ergonomics
- ▶ Female and male models with small, medium, and large stature

Layout planning for transfer systems

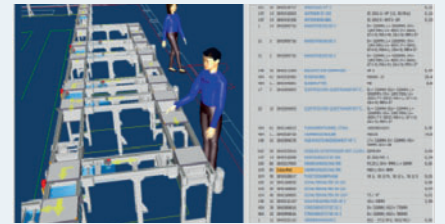

Your advantages:

- ▶ Layout Designer for planning of complete conveyor systems
- ▶ Design logic supports fast, error-free component assembly
- ▶ Consideration of the system environment with the option of adding room planning elements

A good grip on everything with MTpro

From technical data, to order information and CAD models, to assembly instructions and spare parts displays: the MTpro planning software offers you everything you need for planning and constructing frames, enclosures, flow racks, workstations, or transfer systems at a glance.

Your system is assembled on the screen intuitively via drag & drop and the snap function – no complex CAD program is required. You can easily optimize your design with ergonomic components using the integrated ManModel function.

At the press of a button, you can generate complete parts lists including accessories and all small parts and submit your order directly online.

Versatile interfaces enable the convenient further processing of layouts, CAD models, and order data.

Suitable for the entire assembly technology range

MTpro supports you in constructing frames and enclosures with the basic elements of assembly technology, as well as in planning and ergonomically designing Manual Production Systems. In addition, you can create layouts for complete chain conveyors and transfer systems in next to no time.

Customer-specific solutions and projects – individual and application-oriented



From the first customer meeting to the complete system approval: Rexroth supports you during all phases in realizing your projects for material flow and handling technology.

We use sophisticated technologies to find the most cost-effective, efficient, and productive solution for you: mechanical components and modules, electrical drive and control technology, and pneumatic modules.

Our competent customer consultation is characterized by many years of experience in all aspects of assembly technology, starting with comprehensive industry expertise, and based on our versatile range of products.

Our services result in overall solutions that fully meet your needs.

With qualified project management, we ensure that agreed deadline and cost targets can be achieved without making any compromises.

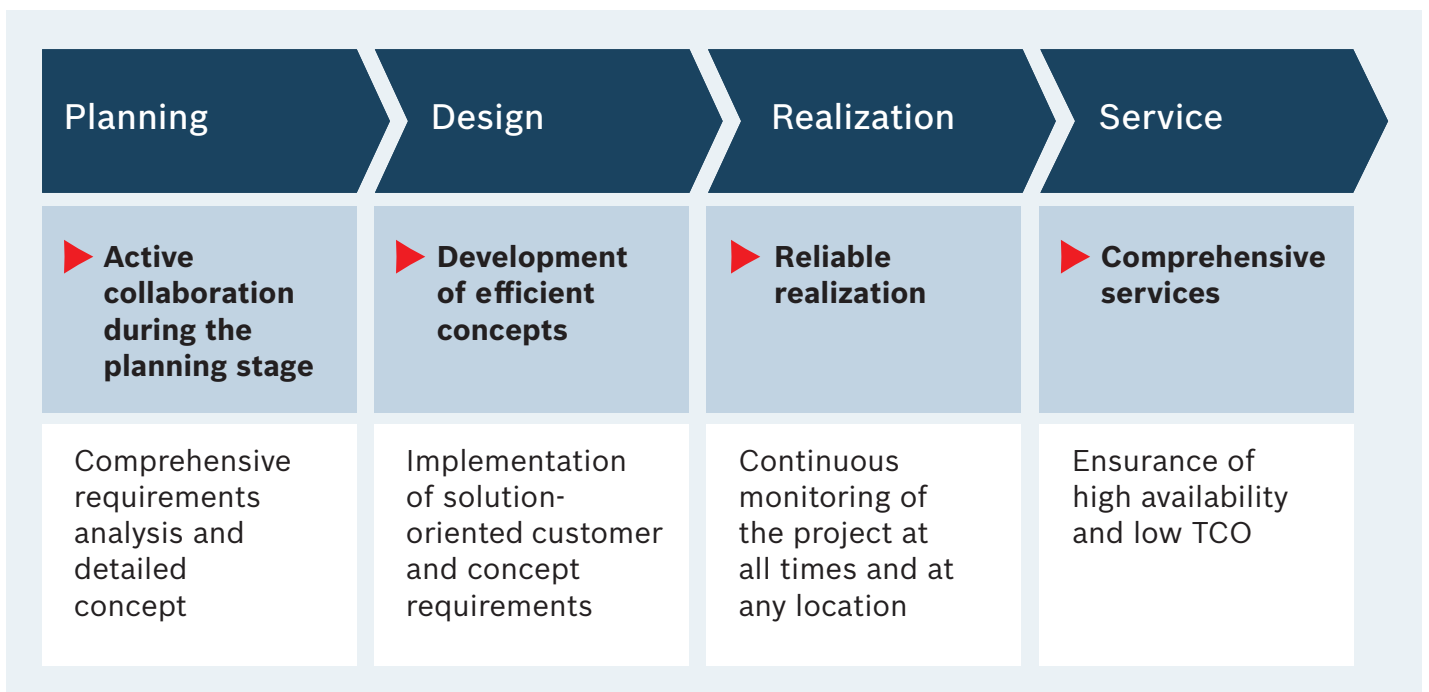

Your advantages

- ▶ Concentration on the core competence (process)
- ▶ Turnkey systems/sub-systems
- ▶ Technically optimized layout
- ▶ Overall project planning across all systems
- ▶ Delivery of systems coordinated to the progress of the customer project
- ▶ Transparent quality management/documentation including safety rating of the overall system
- ▶ On request, transfer of risk at the destination
- ▶ Project-specific warranty and service agreements

Project examples



▲ TS 2*plus* and TS 1 linking systems for transporting plants

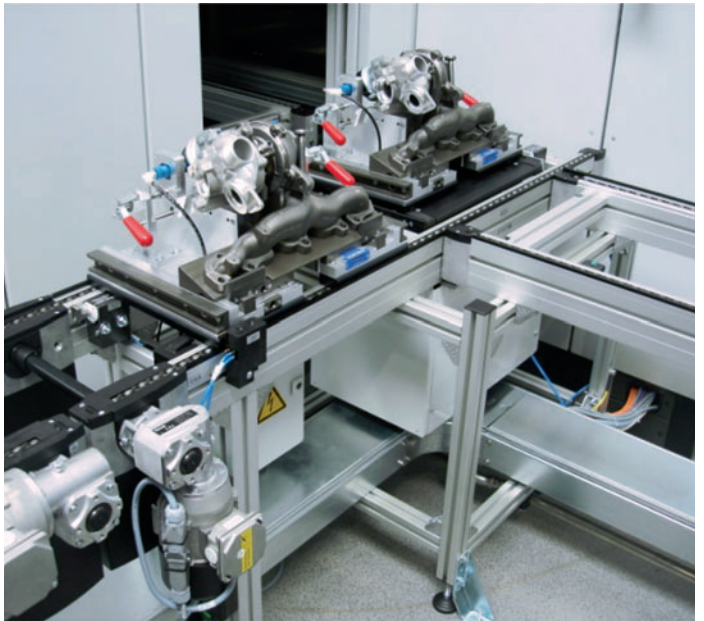

▲ Exhaust gas turbocharger final assembly



▲ VarioFlow 90 linking system for automotive gearbox machining



▲ TS 2*pv* linking system for solar panel production

Rexroth Service – Your key to higher productivity

Maximum equipment availability and high efficiency throughout the entire lifecycle of your machines and plants: These are key factors that determine the productivity of your manufacturing processes. Rexroth offers a comprehensive range of services to help you achieve these targets. Both, globally and across all industry sectors and machines.



Our modular services reduce the complexity and costs associated with maintaining and repairing your production equipment. We guarantee quick access to qualified technicians who solve problems at the root, thanks to their comprehensive knowledge of all drive and control technologies. Besides we ensure expedited diagnosis and quick delivery of spare parts while minimizing costs by having specialist workshops close to you repair and overhaul worn components and modules. All carried out by uniformly high qualified personnel, covered by our network extended to more than 80 countries.

In addition, we keep your machines fit throughout their entire lifecycle and upgrade their efficiency to the latest state of the art. We analyze the benefits of retrofit measures, taking over the implementation in a practical manner – working together with you. Summarized, we combine higher productivity with better energy efficiency and de-fined safety standards – reducing your total cost of ownership significantly. Permanently boost your productivity with Rexroth as your service partner for all your machinery.



Spare parts



Repairs



Field service



Hotline



Retrofit and Modernization

Detailed information is available from
www.boschrexroth.com/service



Bosch Rexroth AG

Postfach 30 02 07
70442 Stuttgart, Germany
www.boschrexroth.com

You can find local contact information at:

www.boschrexroth.com/contact

The data specified serve only to describe the product.

Due to continuous product advancements, no statements concerning a certain condition or suitability for a certain application can be derived from our information. The information given does not release the user from the obligation of own judgment and verification.

It must be remembered that our products are subject to a natural process of wear and aging.